

F X V 可変勾配側溝 / 標準タイプ

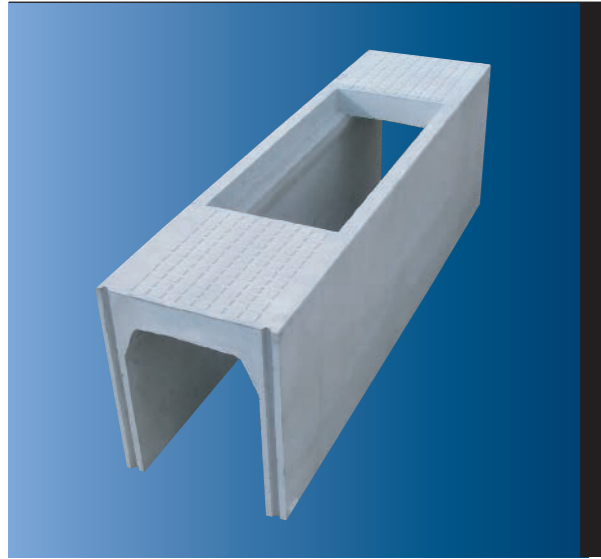

T-25 縦断荷重対応

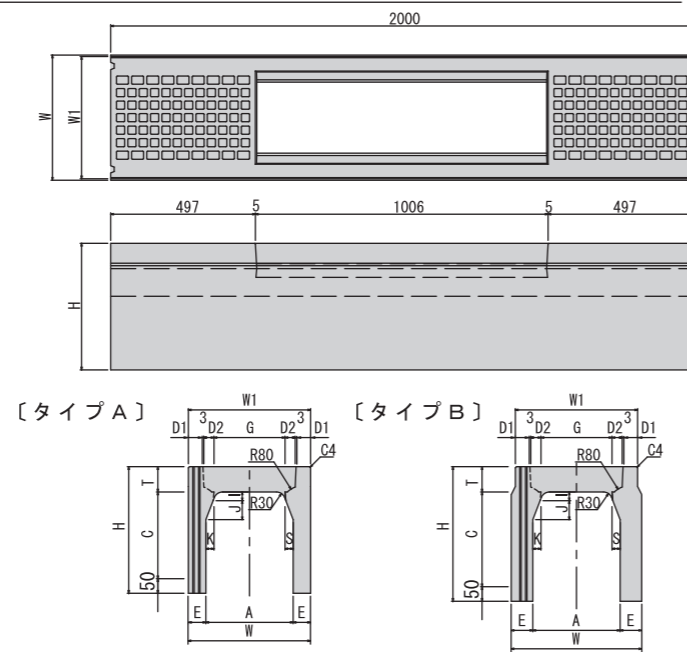

| タイプ | 呼び名 | 規格寸法値(mm) | | | | | | | | | | | | | 重量(kg) | |
|---------|----------|-----------|------|-----|-----|------|-----|----|-----|----|-----|----|----|----|--------|------|
| | | A | C | W | W1 | H | T | D1 | D2 | E | G | I | J | K | | S |
| A | 300×300 | | 298 | | | 435 | | | | | | | | | | 320 |
| | 300×400 | | 398 | 420 | | 535 | | | 60 | | | | | | | 376 |
| | 300×500 | | 498 | | | 635 | | | | | | | | | | 433 |
| B | 300×600 | | 598 | 430 | | 735 | | | 65 | | | | | | | 519 |
| | 300×700 | | 698 | | 420 | 835 | 87 | 50 | 35 | | 244 | 30 | 65 | 28 | 36.5 | 580 |
| | 300×800 | | 798 | | | 935 | | | | | | | | | | 719 |
| | 300×900 | | 898 | 450 | | 1035 | | | 75 | | | | | | | 789 |
| | 300×1000 | | 998 | | | 1135 | | | | | | | | | | 953 |
| | 300×1100 | | 1098 | | 470 | 1235 | | | 85 | | | | | | | 1034 |
| | 300×1200 | | 1198 | | | 1335 | | | | | | | | | | 1112 |
| | 400×400 | | 398 | | | 550 | | | | | | | | | | 453 |
| | 400×500 | | 498 | 530 | | 650 | | | 65 | | | | | | | 514 |
| 400×600 | | 598 | | | 750 | | | | | | | | | | 575 | |
| B | 400×700 | | 698 | 540 | | 850 | | | 70 | | | | | | | 671 |
| | 400×800 | | 798 | | 530 | 950 | 102 | 55 | 40 | | 334 | 40 | 70 | 33 | 47.1 | 736 |
| | 400×900 | | 898 | | | 1050 | | | | | | | | | | 890 |
| | 400×1000 | | 998 | 560 | | 1150 | | | 80 | | | | | | | 965 |
| | 400×1100 | | 1098 | | | 1250 | | | | | | | | | | 1145 |
| | 400×1200 | | 1198 | | 580 | 1350 | | | 90 | | | | | | | 1229 |
| | 400×1300 | | 1298 | | | 1450 | | | | | | | | | | 1314 |
| | 500×400 | | 398 | | | 565 | | | | | | | | | | 555 |
| | 500×500 | | 498 | | | 665 | | | | | | | | | | 625 |
| B | 500×600 | | 598 | 650 | | 765 | | | 75 | | | | | | | 696 |
| | 500×700 | | 698 | | | 865 | | | | | | | | | | 766 |
| | 500×800 | | 798 | | | 965 | | | | | | | | | | 837 |
| | 500×900 | | 898 | | 500 | 1065 | 117 | 60 | 45 | 85 | 434 | 40 | 70 | 33 | 47.1 | 997 |
| | 500×1000 | | 998 | | | 1165 | | | | | | | | | | 1077 |
| | 500×1100 | | 1098 | | | 1265 | | | | | | | | | | 1152 |
| | 500×1200 | | 1198 | | | 1365 | | | | | | | | | | 1352 |
| | 500×1300 | | 1298 | | | 1465 | | | | | | | | | | 1442 |
| | 500×1400 | | 1398 | 690 | | 1565 | | | 95 | | | | | | | 1531 |
| A | 600×400 | | 398 | | | 580 | | | | | | | | | | 645 |
| | 600×500 | | 498 | | | 680 | | | | | | | | | | 720 |
| | 600×600 | | 598 | 760 | | 780 | | | 80 | | | | | | | 795 |
| | 600×700 | | 698 | | | 880 | | | | | | | | | | 870 |
| | 600×800 | | 798 | | | 980 | | | | | | | | | | 945 |
| | 600×900 | | 898 | | 600 | 1080 | 132 | 65 | 50 | | 524 | 45 | 75 | 38 | 56 | 1020 |
| | 600×1000 | | 998 | | | 1180 | | | | | | | | | | 1271 |
| | 600×1100 | | 1098 | | | 1280 | | | | | | | | | | 1365 |
| | 600×1200 | | 1198 | 780 | | 1380 | | | 90 | | | | | | | 1459 |
| B | 600×1300 | | 1298 | | | 1480 | | | | | | | | | | 1553 |
| | 600×1400 | | 1398 | 800 | | 1580 | | | 100 | | | | | | | 1647 |
| | 600×1500 | | 1498 | | | 1680 | | | | | | | | | | 1741 |

F X V 可変勾配側溝 / 集水タイプ

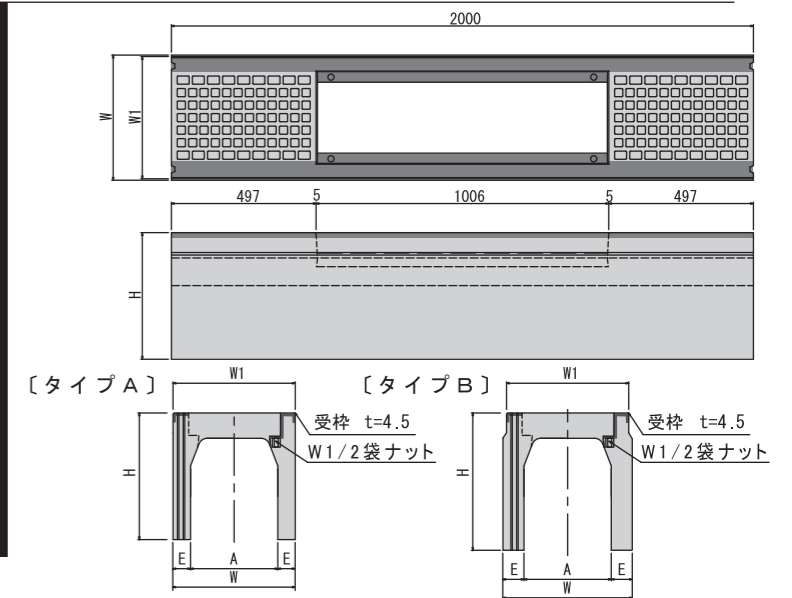
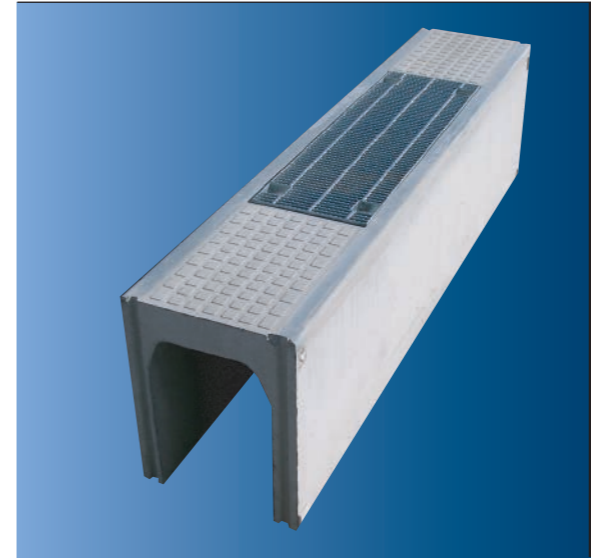

| 呼び名 | 規格寸法値(mm) | | | | | | 重量(kg) |
|----------|-----------|---|----|-----|------|----|--------|
| | A | E | W | W1 | H | E | |
| 300×300 | | | | | 435 | | 320 |
| 300×400 | | | 60 | 420 | 535 | 60 | 376 |
| 300×500 | | | | | 635 | | 433 |
| 300×600 | | | 65 | 430 | 735 | 65 | 519 |
| 300×700 | | | | | 835 | | 580 |
| 300×800 | | | 75 | 450 | 935 | 75 | 719 |
| 300×900 | | | | | 1035 | | 789 |
| 300×1000 | | | | | 1135 | | 953 |
| 300×1100 | | | 85 | 470 | 1235 | 85 | 1034 |
| 300×1200 | | | | | 1335 | | 1112 |
| 400×400 | | | | | 550 | | 453 |
| 400×500 | | | 65 | 530 | 650 | 65 | 514 |
| 400×600 | | | | | 750 | | 575 |
| 400×700 | | | 70 | 540 | 850 | 70 | 671 |
| 400×800 | | | | | 950 | | 736 |
| 400×900 | | | 80 | 560 | 1050 | 80 | 890 |
| 400×1000 | | | | | 1150 | | 965 |
| 400×1100 | | | | | 1250 | | 1145 |
| 400×1200 | | | 90 | 580 | 1350 | 90 | 1229 |
| 400×1300 | | | | | 1450 | | 1314 |

| 呼び名 | 規格寸法値(mm) | | | | | | 重量(kg) |
|----------|-----------|-----|-----|-----|------|-----|--------|
| | A | E | W | W1 | H | E | |
| 500×400 | | | | | 565 | | 555 |
| 500×500 | | | | | 665 | | 625 |
| 500×600 | | 75 | 650 | | 765 | 75 | 696 |
| 500×700 | | | | | 865 | | 766 |
| 500×800 | | | | | 965 | | 837 |
| 500×900 | | | 500 | 650 | 1065 | | 997 |
| 500×1000 | | 85 | 670 | 650 | 1165 | 85 | 1077 |
| 500×1100 | | | | | 1265 | | 1152 |
| 500×1200 | | | | | 1365 | | 1352 |
| 500×1300 | | | | | 1465 | | 1442 |
| 500×1400 | | 95 | 690 | | 1565 | 95 | 1531 |
| 500×1500 | | | | | 1665 | | 1620 |
| 600×400 | | | | | 580 | | 645 |
| 600×500 | | | | | 680 | | 720 |
| 600×600 | | 80 | 760 | | 780 | 80 | 795 |
| 600×700 | | | | | 880 | | 870 |
| 600×800 | | | | | 980 | | 945 |
| 600×900 | | | 600 | 760 | 1080 | | 1020 |
| 600×1000 | | | | | 1180 | | 1271 |
| 600×1100 | | 90 | 780 | 760 | 1280 | 90 | 1365 |
| 600×1200 | | | | | 1380 | | 1459 |
| 600×1300 | | | | | 1480 | | 1553 |
| 600×1400 | | 100 | 800 | | 1580 | 100 | 1647 |
| 600×1500 | | | | | 1680 | | 1741 |

F X V 可変勾配側溝 / 短切タイプ



● カット専用 (L=1500・L=1000)

現場での長さ調整やコーナー対応において、標準製品をカットすると強度不足となる場合には、カットしろを大きく取る事のできる長さ調整タイプを使用します。

F X V 可変側溝調整タイプは約 1m ~ 1.5m までの幅広い調整が可能です。蓋は一枚掛けとなります。

F X 蓋 / 車道用

T-25 縦断荷重対応

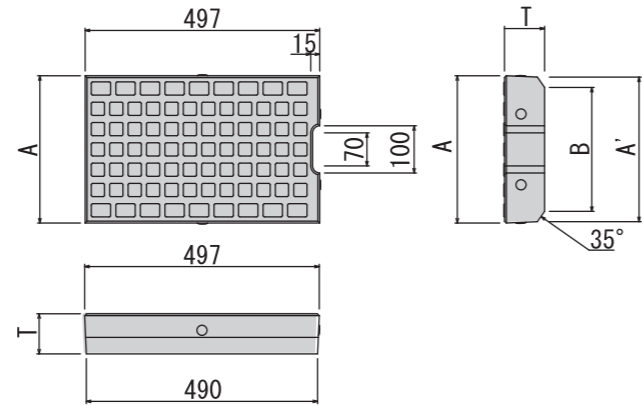
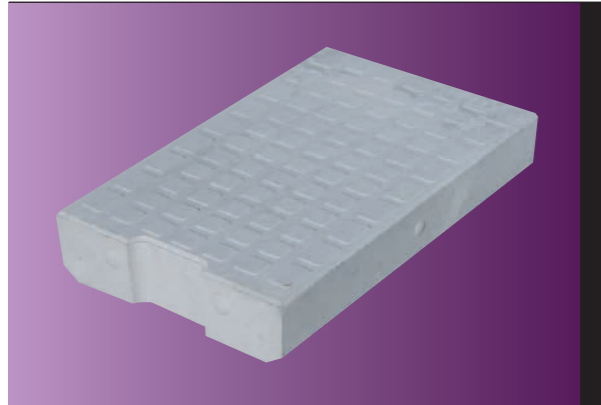

| 呼び名 | 規格寸法値 (mm) | | | | 重量 (kg) |
|------|------------|-----|-------|-----|---------|
| | A | A' | B | T | |
| 250用 | 262 | 255 | 212.5 | 80 | 24 |
| 300用 | 312 | 305 | 262.5 | 85 | 31 |
| 400用 | 412 | 403 | 353.2 | 100 | 48 |
| 500用 | 522 | 513 | 456.0 | 115 | 70 |
| 600用 | 622 | 613 | 556.0 | 130 | 88 |

F X 蓋 / 歩道用

T-2 対応

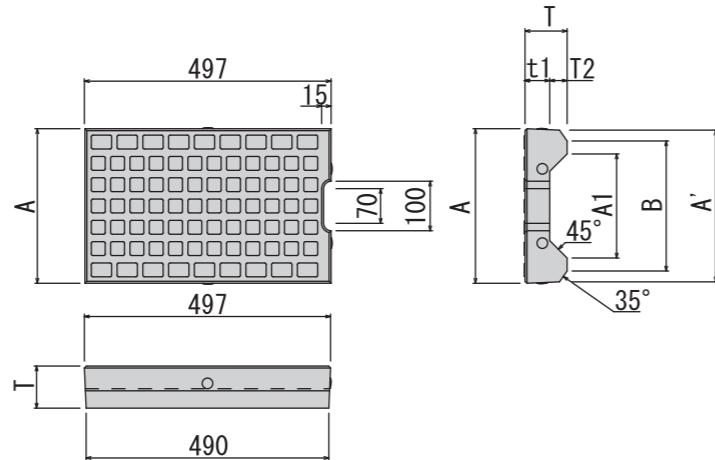

| 呼び名 | 規格寸法値 (mm) | | | | | | | 重量 (kg) |
|------|------------|-----|-----|-------|-----|----|----|---------|
| | A | A' | A1 | B | T | T1 | T2 | |
| 250用 | 262 | 255 | 180 | 212.5 | 80 | 50 | 30 | 18 |
| 300用 | 312 | 305 | 210 | 262.5 | 85 | 50 | 35 | 24 |
| 400用 | 412 | 403 | 300 | 353.2 | 100 | 55 | 45 | 34 |
| 500用 | 522 | 513 | 400 | 456.0 | 115 | 65 | 50 | 49 |
| 600用 | 622 | 613 | 500 | 556.0 | 130 | 75 | 55 | 59 |

F X グレーチング蓋 / 車道用・歩道用

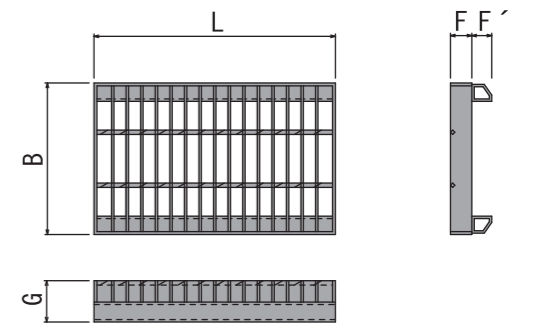
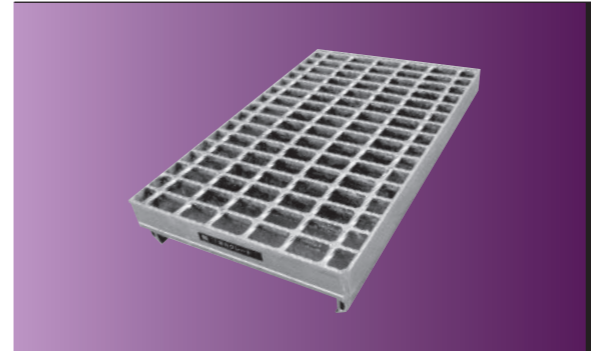

| 呼び名 | 規格寸法値 (mm) | | | | | 重量 (kg) | | | |
|-----|------------|------|------|------|-----|---------|------|-----|-----|
| | G | F | F' | B | L | | | | |
| 車道用 | 250用 | 80 | 44 | 35 | 260 | 995 | 21.2 | | |
| | | 495 | 11.5 | 300用 | 85 | 44 | 40 | 310 | 995 |
| | 495 | 14.1 | 400用 | | 100 | 55 | 40 | 410 | 995 |
| | 495 | 20.8 | | 500用 | 115 | 75 | 35 | 520 | 995 |
| | 495 | 31.2 | 600用 | | 130 | 90 | 35 | 620 | 995 |
| | 495 | 42.4 | | | | | | | |

| 呼び名 | 規格寸法値 (mm) | | | | | 重量 (kg) | | | |
|-----|------------|------|------|------|-----|---------|------|-----|-----|
| | G | F | F' | B | L | | | | |
| 歩道用 | 250用 | 80 | 25 | 55 | 260 | 995 | 18.0 | | |
| | | 495 | 9.8 | 300用 | 85 | 25 | 60 | 310 | 995 |
| | 495 | 10.5 | 400用 | | 100 | 32 | 75 | 410 | 995 |
| | 495 | 14.3 | | 500用 | 115 | 32 | 83 | 520 | 995 |
| | 495 | 16.6 | 600用 | | 130 | 38 | 92 | 620 | 995 |
| | 495 | 21.8 | | | | | | | |

F X 柵

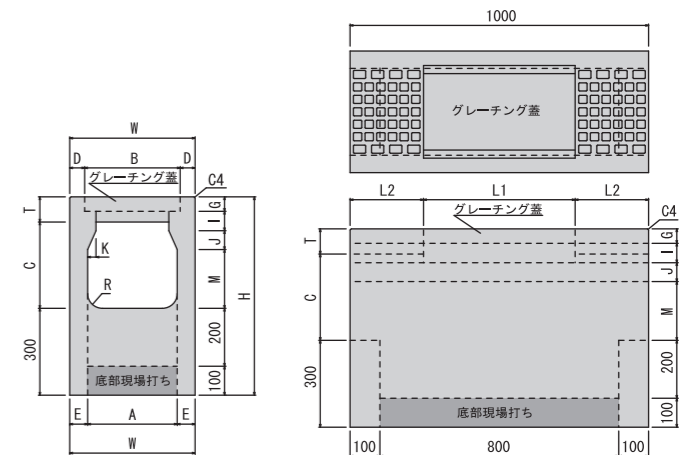

| 呼び名 | 規格寸法値 (mm) | | | | | | | | | | | | | | | | 重量 (kg) |
|-----------|------------|-----|-----|-----|----|----|------|----|----|----|-----|-------|-----|----|-----|-----|---------|
| | A | B | C | D | E | G | H | I | J | K | L1 | L2 | M | R | T | W | |
| 250 × 250 | | | 248 | | | | 630 | | | | | | 153 | | | | 263 |
| 250 × 300 | | | 298 | | | | 680 | | | | | | 203 | | | | 249 |
| 250 × 400 | 250 | 270 | 398 | 45 | 55 | 50 | 780 | 62 | 65 | 28 | 508 | 246 | 303 | 40 | 82 | 360 | 275 |
| 250 × 500 | | | 498 | | | | 880 | | | | | | 403 | | | | 301 |
| 250 × 600 | | | 598 | | | | 980 | | | | | | 503 | | | | 327 |
| 300 × 300 | | | 298 | | | | 685 | | | | | | 203 | | | | 274 |
| 300 × 400 | | | 398 | | | | 785 | | | | | | 303 | | | | 303 |
| 300 × 500 | 300 | 320 | 498 | 50 | 60 | 50 | 885 | 67 | 65 | 28 | 508 | 246 | 403 | 50 | 87 | 420 | 332 |
| 300 × 600 | | | 598 | | | | 985 | | | | | | 503 | | | | 361 |
| 400 × 400 | | | 398 | | | | 800 | | | | | | 288 | | | | 347 |
| 400 × 500 | | | 498 | | | | 900 | | | | | | 388 | | | | 378 |
| 400 × 600 | 400 | 420 | 598 | 55 | 65 | 56 | 1000 | 86 | 70 | 33 | 519 | 240.5 | 488 | 50 | 102 | 530 | 409 |
| 500 × 500 | | | 498 | | | | 915 | | | | | | 388 | | | | 447 |
| 500 × 600 | 500 | 520 | 598 | 60 | 75 | 71 | 1015 | 86 | 70 | 33 | 519 | 240.5 | 488 | 50 | 117 | 650 | 483 |
| 600 × 600 | | | 598 | | | | 1030 | | | | | | 478 | | | | 559 |
| 600 × 700 | 600 | 630 | 698 | 653 | 80 | 96 | 1130 | 81 | 75 | 33 | 519 | 240.5 | 578 | 60 | 132 | 760 | 600 |